



MARBLE & ONYX  
COLLECTION

PATAGONIA 



**Tagina**  
ITALY'S BEST SURFACES



# PATAGONIA

**PATAGONIA** by **Tagina** è un'interpretazione originale della pietra vulcanica sudamericana da cui prende il nome. Liberata dai blocchi di fredda durezza con grande sensibilità e certosina maestria, prende forma e vita un marmo nuovo, un cristallo dagli effetti grafici di rara bellezza dove note cromatiche formano intrecci e venature su sfondi traslucidi, componendo superfici tra le più scenografiche nel suo genere, il tutto esaltato dal formato della grande lastra 120x270 in cui è disponibile.

**PATAGONIA** by **Tagina** is an original interpretation of the South American volcanic stone from which it takes its name. Freed from blocks of cold hardness with great sensitivity and painstaking craftsmanship, a new marble takes shape and life, a crystal with graphic effects of rare beauty where chromatic notes form weaves and veins on translucent backgrounds, composing surfaces that are among the most spectacular of its kind. All enhanced by the size of the large 120x270 slab in which it is available.

**PATAGONIA** by **Tagina** est une interprétation originale de la pierre volcanique sud-américaine dont elle tire son nom. Libéré des blocs de dureté froide avec une grande sensibilité et un travail artisanal méticuleux, un nouveau marbre prend forme, un cristal aux effets graphiques d'une rare beauté où les notes chromatiques forment des entrelacements et des veines sur des fonds translucides, composant des surfaces parmi les plus scéniques, le tout mis en valeur par les dimensions de la grande dalle 120x270 disponible.

**PATAGONIA** by **Tagina** ist eine originelle Interpretation des südamerikanischen Vulkangesteins, von dem es seinen Namen hat. Mit viel Fingerspitzengefühl und handwerklichem Geschick aus harten Blöcken gewonnen, nimmt ein neuer Marmor Gestalt und Leben an, ein Kristall mit grafischen Effekten von seltener Schönheit, bei dem chromatische Töne auf durchscheinendem Grund Geflechte und Maserungen bilden, die zu den spektakulärsten Oberflächen seiner Art gehören, was durch die Größe der 120x270-Platte, in der er erhältlich ist, noch verstärkt wird.

100% Made in Italy





NORDLYS  
JEWELRY

NORDLYS  
JEWELRY

RIVESTIMENTO . WALL: TURCHESE 120x270 Lucidato Ret. - Collection METAL CORTEN 120x280 Nat. Ret.  
BANCONI . COUNTER: TURCHESE 120x270 Lucidato Ret. - Collection METAL CORTEN 120x280 Nat. Ret.  
PAVIMENTO . FLOOR: TURCHESE 120x270 Lucidato Ret.





RIVESTIMENTO . WALL: CAFFE' 120x270 Lucidato Ret.  
PAVIMENTO . FLOOR: CAFFE' 120x270 Lucidato Ret.









RIVESTIMENTO . WALL: BIANCO 120x270 Lucidato Ret.  
PAVIMENTO . FLOOR: ZAFFIRO 120x270 Lucidato Ret.



RIVESTIMENTO . WALL: CASHMERE 60X120 Lucidato Ret.  
PAVIMENTO . FLOOR: CASHMERE 60X120 Lucidato Ret.









# PATAGONIA

Ogni collezione Tagina rivela la massima cura e una sensibilità artistica raffinata capace di riprodurre la più intima essenza estetica della materia.

Colori e trame ricercate si sommano a caratteristiche tecniche di massima qualità grazie alle tecnologie produttive più avanzate.

Una superficie Tagina è garanzia di eccellenza e prestigio in ogni genere di spazio legato a emozioni inalterabili nel tempo.

Every Tagina collection shows the utmost attention to detail and a sophisticated artistic sensitivity that reproduces the most intimate aesthetic essence of the material. Refined colours and textures combine with the highest-quality technical characteristics thanks to the most advanced manufacturing technologies.

A Tagina surface is a guarantee of excellence and prestige in any kind of environment connected to emotions impervious to time.

Chaque collection Tagina révèle un soin maximal et une sensibilité artistique raffinée capable de reproduire l'essence esthétique la plus intime de la matière.

Couleurs et motifs recherchés s'ajoutent à des caractéristiques techniques d'une qualité maximale grâce aux technologies de production les plus avancées.

Une surface Tagina est une garantie d'excellence et de prestige dans tous les types d'espace lié à des émotions inaltérables dans le temps.

Jede Tagina-Kollektion zeugt von größter Sorgfalt und einem raffinierten künstlerischen Gespür, das die intimste ästhetische Essenz des Materials wiederzugeben vermag. Raffinierte Farben und Texturen ergänzen sich durch modernste Produktionstechnologien mit hochwertigen technischen Eigenschaften.

Eine Oberfläche von Tagina ist eine Garantie für Exzellenz und Wertigkeit in jeder Art von Raum, verbunden mit dauerhaften Emotionen.



# BIANCO





CASHMERE



ZAFFIRO





TURCHESE



CAFFE'





**FORMATI**

Sizes / Formats / Formate

6 mm . 120x270 - 48"x106"  
9 mm . 120x120 - 48"x48" / 60x120 - 24"x48"

**GRANDI VARIETÀ DI GRAFICHE**

Wide variety of graphics / Grande variété des graphismes / Große Vielfalt der Graphiken



Ambienti unici e originali grazie ad una grande varietà di grafiche.  
The greatly varying patterns featured result in unique and original interiors.  
Des espaces uniques et originaux grâce à une grande variété de graphismes.  
Einzigartige und originelle Räume dank einer großen Vielfalt von Grafiken.

Il numero delle grafiche può variare rispetto a quanto riportato e può essere differente tra i vari formati e/o colori.  
The number of the patterns may differ from that shown herewith and may also vary depending on the selected size and/or colour.  
Le nombre de graphismes peut varier par rapport à ce qui est reporté et il peut varier suivant les différents formats et/ou couleurs.  
Die Anzahl der Grafiken kann von den Angaben abweichen und zwischen den verschiedenen Formaten und/oder Farben unterschiedlich sein.

**COLORI**

Colours / Couleurs / Farben



BIANCO



CASHMERE



ZAFFIRO

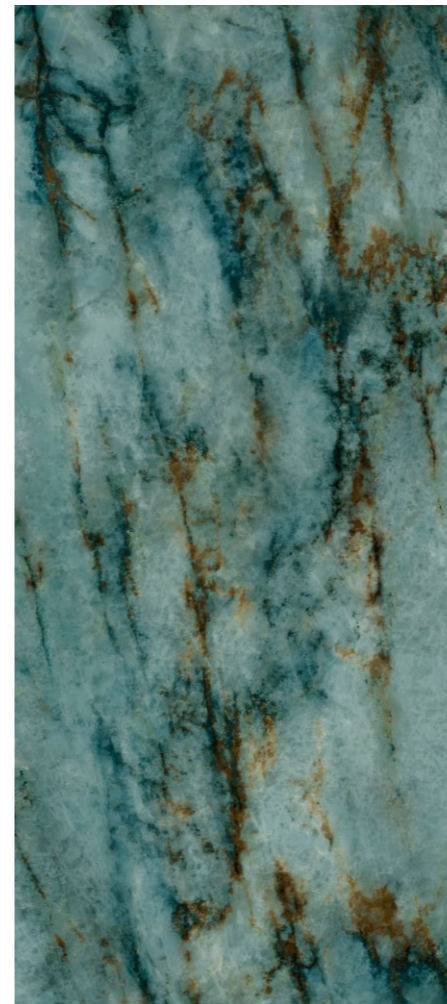

TURCHESE



CAFFÈ



**Spessore . Thickness . Epaisseur . Stärke - 6 mm**

















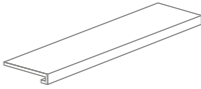
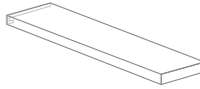
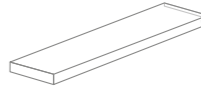



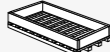

**Lastre in gres porcellanato pressate a secco.** Dry-pressed porcelain stoneware slabs. Dalles en grès cérame pressées à sec. Trocken gepresste Platten aus Feinsteinzeug.

**Spessore . Thickness . Epaisseur . Stärke - 9 mm**

**Gres porcellanato colorato in massa.** Full-body coloured porcelain stoneware. Grès cérame coloré dans la masse. In der Masse gefärbtes Feinsteinzeug.

**TABELLA RIEPILOGATIVA**

Summary table  
Tableau récapitulatif  
Zusammenfassende Tabelle

														
		120x270 48"x106"	120x120 48"x48"	60x120 24"x48"	Mosaico (5x5) 30x30 12"x12"	*** Copriscipigolo triangolare 0,8x120 1/4"x48"	1,4x120 1/2"x48"	Ang. Copriscipigolo triang. 0,8x0,8 1/4"x1/4"	1,4x1,4 1/2"x1/2"	Battiscopa 6,3x120 2 1/2"x48"	* Gradino a C 33x120x3,2h 13"x48"x1 1/4" h	* Ang. Gradino a C - DX 33x120x3,2h 13"x48"x1 1/4" h	* Ang. Gradino a C - SX 33x120x3,2h 13"x48"x1 1/4" h	
SPESSORE - THICKNESS - EPAISSEUR - STÄRKE		6 mm	9 mm	9 mm	9 mm	6 mm	9 mm	6 mm	9 mm	9 mm	9 mm	9 mm	9 mm	
	○ Lucidato Ret.	125071	125091	125101	125200	125400	125420	125410	125430	125250	125300	125310	125320	
	□ Nat. Ret.	-	-	125102	-	-	125421	-	125435	125251	125301	125311	125321	
	○ Lucidato Ret.	125072	125092	125103	125202	125402	125422	125411	125431	125252	125302	125312	125322	
	○ Lucidato Ret.	125073	125093	125105	125204	125404	125424	125412	125432	125254	125304	125314	125324	
	○ Lucidato Ret.	125074	125094	125107	125206	125406	125426	125413	125433	125256	125306	125316	125326	
	○ Lucidato Ret.	125075	125095	125109	125208	125408	125428	125414	125434	125258	125308	125318	125328	
<b>CODICE PREZZO - PRICE CODE</b> CODE PRIX - PREISGRUPPE	○ Lucidato Ret.	236F € 126,26/m <sup>2</sup>	208F € 111,28/m <sup>2</sup>	128F € 68,48/m <sup>2</sup>	310F € 165,85/m <sup>2</sup>	116P € 62,06/pc	116P € 62,06/pc	62P € 33,17/pc	62P € 33,17/pc	36P € 19,26/pc	486P € 260,01/pc	594P € 317,79/pc	594P € 317,79/pc	
	□ Nat. Ret.	-	-	94F € 50,29/m <sup>2</sup>	-	-	116P € 62,06/pc	-	62P € 33,17/pc	34P € 18,19/pc	446P € 238,61/pc	554P € 296,39/pc	554P € 296,39/pc	
<b>MQ x pezzo - Sqm x pcs</b>		3,24												
<b>Kg x pezzo - Kg x pcs</b>		47												
	<b>Cassa</b> Crate 292x145x34h			<b>Pallet speciale</b> Special pallet 122x143		<b>Pallet</b> 80x120		<b>Pallet</b> 80x120		<b>Pallet</b> 80x120		<b>Pallet</b> 80x120		<b>Pallet</b> 80x120
	<b>N°</b>	20												
<b>m<sup>2</sup></b>	64,8													
<b>** Kg</b>	1030													
			2	2	11	6	6			9	2	1	1	
<b>m<sup>2</sup> x</b>			2,88	1,44	0,99									
<b>Kg x</b>			56	28,6	18	1,2	2			16	22,9	11,5	11,5	
			18	35										
<b>m<sup>2</sup> x</b>			51,84	50,4										
<b>** Kg x</b>			1061	1021										
<b>h x</b>														
<b>Imballo (tara) - Packaging (tare)</b>		(90)	(53)	(20)	(20)					(20)	(20)	(20)	(20)	
	<b>Cavalletto</b> A-Frame 75x290x145h													
	<b>N°</b>	44												
<b>m<sup>2</sup></b>	147,84													
<b>** Kg</b>	2273													
<b>Imballo (tara) - Packaging (tare)</b>		(205)												

I pesi riportati in tabella sono indicativi e potrebbero essere soggetti a leggere variazioni.  
The weights stated in the chart may undergo slight changes for production reasons.  
Les poids indiqués dans le tableau peuvent subir de légères variations pour des raisons de production.  
Die in der Tabelle angegebenen Gewichte können aus Produktionsgründen geringfügigen Abweichungen unterliegen.

Non si garantisce l'abbinabilità tra fondi di spessori diversi e tra fondo e pezzo speciale.  
It is not guaranteed that background tiles with different thicknesses can be used together, nor is it guaranteed for background tiles and trims.  
Nous ne garantissons pas la possibilité de combiner des carrelages de sol de différentes épaisseurs et un carrelage de sol avec une pièce spéciale.  
Die Kombinierbarkeit von Fliesen unterschiedlicher Stärke sowie zwischen Fliese und Formteil kann nicht garantiert werden.

\* A disposizione solo su richiesta. Tempi di consegna 30 gg.  
Available upon request only. Delivery terms: 30 days.  
Disponible seulement sur requête. Délais de livraison: 30 jours.  
Verfügbar auf Anfrage. Lieferzeit: 30 Tage.

\*\* Il peso è comprensivo dell'imballo.  
The total weight includes the packaging.  
Le poids comprend aussi l'emballage.  
Das Gesamtgewicht enthält auch die Verpackung.

\*\*\* Vendita a scatola completa.  
Full box sale.  
Vente à la boîte complète.  
Volle Kartons.

○ Naturale e rettificato.  
Natural and rectified.  
Naturel et rectifié.  
Natur Oberfläche und kalibriert.

○ Lucidato e rettificato.  
Glossy/Polished and rectified.  
Brillant et rectifié.  
Glossy/Shiny und kalibriert.



# Pezzi speciali: massima cura in ogni dettaglio

Special pieces: the utmost care in every detail.  
Pièces spéciales : le soin maximal dans le moindre détail.  
Formteile: maximale Sorgfalt in jedem Detail.



## Il fascino tradizionale del gradino a "C"

The traditional appeal of the "C" step.  
Le charme traditionnel de l'étape « C ».  
Der traditionelle Charme der „C“-Stufe.

Tagina pone attenzione a tutte le componenti architettoniche degli spazi da abitare. Ai gradini sono dedicati pezzi speciali appositamente progettati per ottenere il massimo risultato estetico. La gamma comprende un elemento "gradino a C" al quale si possono affiancare gli elementi che completano gli angoli sinistro e destro.

Tagina takes great care over all the architectural elements of the living spaces. Special pieces are used for the stairs, specially designed to obtain the maximum aesthetic result. The range includes a "C-step" element which can be combined with the elements that complete the left and right corners.

Tagina prête attention à toutes les composantes architecturales des espaces de vie. Les étapes sont dédiées à des pièces spéciales spécialement conçues pour obtenir un résultat esthétique maximal. La gamme comprend un élément « marche en C » auquel vous pouvez assortir les autres éléments qui complètent les angles gauche et droit.

Tagina achtet auf alle architektonischen Komponenten der Wohnräume. Den Stufen sind Spezialteile gewidmet, um ein optimales ästhetisches Ergebnis zu erzielen. Das Sortiment umfasst ein „C-Stufen-Element“, das durch Elemente zur Vervollständigung der linken und rechten Ecke ergänzt werden kann.

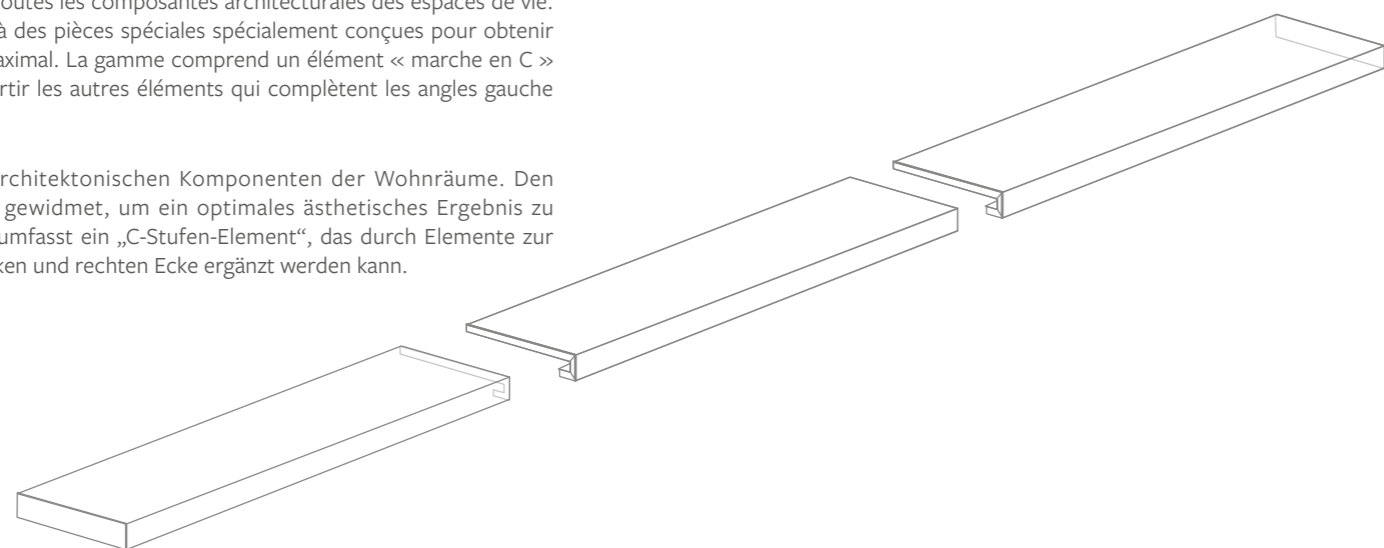

## Il "coprispigolo triangolare"

The "triangular edge cover".  
Le « cache-arête triangulaire ».  
„Dreieckiger Kantenschutz“.

La gamma Tagina include gli elementi "Coprispigolo triangolare" e l' "Angolo Coprispigolo triangolare". Essi consentono di risolvere con eleganza e semplicità problematiche legate alla congiunzione delle lastre in presenza di spigoli e angoli. È possibile adottare questa soluzione sia a rivestimento che a pavimento ad esempio per realizzare gradini o per comporre volumi geometrici.

The range of Tagina includes the "Triangular edge cover and triangular corner edge cover" elements. They allow problems encountered to be solved elegantly and simply when joining slabs where there are edges and corners. It is possible to adopt this solution both for cladding and flooring, e.g. to create steps or compose geometric volumes.

La gamme Tagina comprend les éléments « Cache-arête triangulaire et Angle Cache-arête Triangulaire ». Ils permettent de résoudre avec élégance et simplicité les problèmes liés à l'assemblage des dalles en présence de bords et de coins. Il est possible d'adopter cette solution aussi bien pour le revêtement que pour le dallage, par exemple pour créer des marches ou composer des volumes géométriques.

Das Sortiment Tagina umfasst das Element „Dreieckiger Kantenschutz und Dreieckige Eckabdeckung“. Beide Elemente ermöglichen, mit Eleganz und Einfachheit alle Probleme zu lösen, die mit dem Zusammenfügen der Platten bei Vorhandensein von Kanten und Ecken zusammenhängen. Diese Lösung kann sowohl für Verkleidungen als auch für Böden verwendet werden, beispielsweise um Stufen oder geometrische Volumen zu schaffen.





# Suggerimenti per abbinare colori e stili Tagina

Tips for Matching Colours and Tagina Styles.

Conseils pour faire correspondre les couleurs et les styles Tagina.

Tipps für die Kombination von Tagina-Farben und -Stilen.



CONCRETE & DESIGN

STONE & CLASSIC

WOOD

	BIANCO	CASHMERE		ZAFFIRO		TURCHESE		CAFFÈ	
<b>PATAGONIA CONCRETA</b>	 GRIGIO CHIARO	 GRIGIO CHIARO	 TERRA	 GRIGIO SCURO	 TERRA	 GRIGIO CHIARO	 TERRA	 GRIGIO CHIARO	 TERRA
<b>PATAGONIA PIETRA DI LUNA</b>	 BEIGE	 ARGENT	 BLANC	 NOIR	 ARGENT	 BEIGE	 BLANC	 BLANC	 ARGENT
<b>PATAGONIA APOGEO</b>	 WHITE	 GREY	 WHITE	 GREY	 WHITE	 WHITE	 WHITE	 ANTHRACITE	 BLACK
<b>PATAGONIA PIETRA REGALE</b>	 CHIANALE	 RIVOLI	 CHIANALE	 RIVOLI	 RIVOLI	 OSTANA	 RIVOLI	 ELVA	 OSTANA
<b>PATAGONIA EVOQUE</b>	 KORINA	 BAHIA	 KORINA	 DOUGLAS	 ROVERE	 DOUSSIE	 DOUGLAS	 KORINA	 BAHIA
Colore consigliato per la Fuga Recommended joint colour. Couleur d'échappement recommandée. Empfohlene Farbe für die Fuge.	 RAL 9016 NCS 0510-R	 RAL 9002 NCS 1502-Y	 RAL 7044 NCS S 2005-G60Y	 RAL 7035 NCS 2502-Y	 RAL 7044 NCS S 2005-G60Y				

Per le condizioni generali di vendita e le caratteristiche tecniche consultare [www.tagina.it](http://www.tagina.it)  
 General terms and Sales conditions and Technical features are available on our website [www.tagina.it](http://www.tagina.it)  
 Les Conditions général de vente et les Caractéristiques techniques sont disponibles sur le site web [www.tagina.it](http://www.tagina.it)  
 Allgemeine Verkaufsbedingungen und technische Eigenschaften sind auf unsere Website verfügbar: [www.tagina.it](http://www.tagina.it)

Tagina S.p.A. si riserva di modificare, senza alcun preavviso, il packaging dei prodotti, le grafiche, i colori e i decori riportati nelle immagini che sono pertanto da ritenersi indicative.  
 Tagina S.p.A. reserves the right to change the product packaging, the patterns, colours and decorations shown in the pictures without any prior notice. These aspects, therefore should be considered for illustrative purposes only.  
 Tagina S.p.A. se réserve le droit de modifier, sans préavis, l'emballage des produits, les graphismes, les couleurs et les décors représentés dans les images, fournies à titre indicatif.  
 Die Tagina S.p.A. behält sich vor, die Verpackung der Produkte, die in den Abbildungen gezeigten Grafiken, Farben und Dekors sowie ohne vorherige Ankündigung zu ändern.





**Tagina** S.p.A.  
Via Emilia Ponente, 925  
48014 Castel Bolognese (RA) - Italy  
Tel. +39 0545 197 7303

tagina.it -  DAFIN GROUP

